

FREEPHONE
0800 767583

RMS
DISPLAY + STORAGE SOLUTIONS

CONTENTS

- 1 Wall Channel
- 2 Brackets and Chrome Pipe
- 3 Shelf Brackets & Timber Shelves
- 4 Peg Prongs
- 5 Crossbars and Fittings
- 6 Clothing Racks
- 7 Slatpanel - Display Units
- 8 Slatpanel - Specifications
- 9 Slatpanel Fittings
- 10 Slatpanel Fittings
- 11 Acrylic Slatpanel Fittings
- 12 Metal Slatpanel Fittings
- 13 Brochure Display Units
- 14 Brochure Holders
- 15 Brochure Stands
- 16 Magazine Holders
- 17 Acrylic Displays
- 18 Glass Display Cabinets
- 19 Glass Cabinets - Moduloc
- 20 Display Shelving
- 21 Shelving Accessories
- 22 Library Shelving
- 23 Library Shelving
- 24 Chrome Shelving
- 25 Clothes Hangers
- 26 Mannequins
- 27 Security Mirrors

Can't find what you're looking for? Give us a call, we will help you find it.

FREEPHONE: 0800 RMS LTD (0800 767 583)

or send an email: info@rmsshop.com

or check our website: www.rmsshop.com

WALL CHANNEL

ALUMINIUM MILL FINISH

MO1 Aluminium Mill Finish 9 x 12mm

1003 2.4m length

MO2 Aluminium Mill Finish 19 x 12mm

1009 1.8m length
1011 2.1m length
1012 2.4m length

MO3 Aluminium Mill Finish 19 x 12mm

1020 1.8m length
1021 2.1m length
1022 2.4m length

MO4 Aluminium Mill Finish 30 x 15mm

1024 2.4m length (slotted)
1027 2.4m length (unslotted joiner)

MO5 Aluminium Mill Finish 19 x 12mm

1030 1.8m length
1031 2.1m length
1032 2.4m length

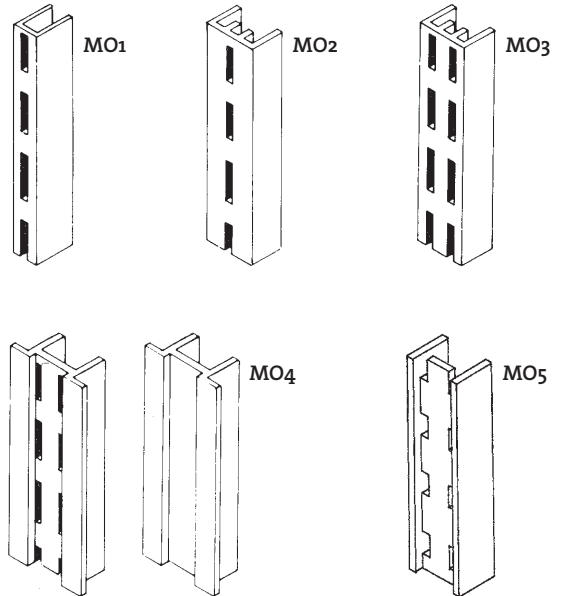

STEEL WALL CHANNEL

SC1 Steel Wall Channel 25 x 12mm

1049 1.8m length
1048 2.1m length
1047 2.4m length

SC2 Steel Wall Channel 25 x 12mm

1049D 1.8m length
1048D 2.1m length
1047D 2.4m length

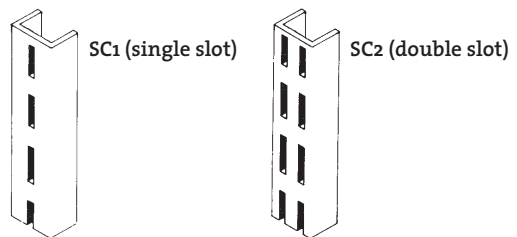

STEEL SECTIONS - Mill Finish

Steel Sections - Mill Finish

1050 S34 - 22 x 22mm - 2.4m length
single slot (2 or 4 sides)
1054 S36 - 32 x 51mm - 2.4m length
double slot 2 sides
1056 S48 - 38 x 38mm - 2.4m length
8mm wide slot 2 or 4 sides
1052 S34 Top and Bottom Sleeves
1064 S36 Top Connector
1065 S36 Bottom Connector
1066 S36 Cover Sleeve
1067 S34 Plastic Cap
1068 S36 Plastic Cap

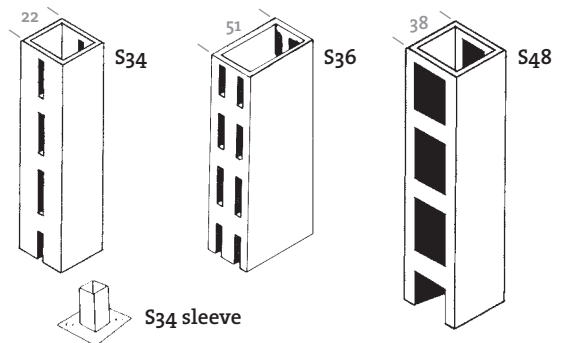

Other lengths and sizes available on request - please enquire

BRACKETS & CHROME PIPE

GENERAL PURPOSE BRACKETS for Glass and Timber Shelving

Showcase – Zinc Plated

1081	100mm SC
1082	150mm SC
1083	200mm SC
1084	250mm SC
1085	300mm SC



Medium Duty – Zinc Plated

1091	250mm MD
1092	300mm MD
1093	350mm MD
1094	400mm MD
1095	450mm MD

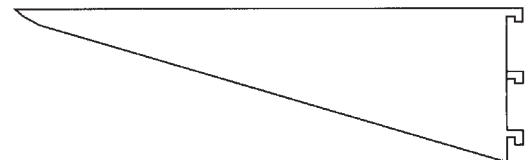
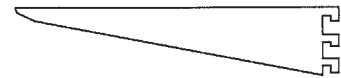

Heavy Duty – Zinc Plated

1101	500mm HD
1102	550mm HD
1103	600mm HD

Adjustable Tilt Brackets Clip-On Style – Zinc Plated

1111	200mm AT
1112	250mm AT
1113	300mm AT
1114	350mm AT
1115	400mm AT
1116	450mm AT

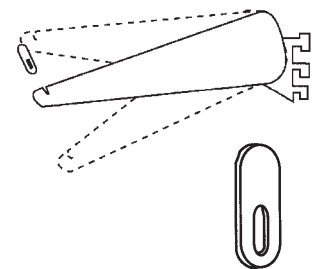

Tilt Support – Zinc Plated

1118	55mm TS
------	---------

SHELF SUPPORTS Clear Plastic

1401	Single GC4 (ea.) Complete with button
1402	Double GC1 (ea.) Complete with button
1400	Shelf Support Button



HANG RAILS & ACCESSORIES

Chrome-plated 25mm Diameter Tubing

1301	725mm
1302	892mm
1302N	892mm Notched
1303	1184mm
1304	1450mm
1305	1784mm
1308	2440mm
1309	3600mm

Custom sizes cut to order

1310	Tube Fixer
1311	Tube Joiner
1312	Tube Plug Plastic
1314	Wall Holder



1311



1310



1312



1314

SHELF BRACKETS & TIMBER SHELVES

LIGHT DUTY SHELF BRACKETS

Colour: White

M1 10 x 75	100 x 75mm
M1 12 x 10	125 x 100mm
M1 15 x 12	150 x 125mm
M1 20 x 15	200 x 150mm
M1 25 x 20	250 x 200mm
M1 30 x 25	300 x 250mm
M1 35 x 30	350 x 300mm
M1 40 x 35	400 x 350mm



HEAVY DUTY SHELF BRACKETS

Colour: White

HD 30 x 21	300 x 210mm
HD 40 x 27	400 x 270mm
HD 50 x 33	500 x 330mm

Custom build also available



REGAL BRACKETS

Colour: White

RB 50	50mm
RB 600	600mm
RB 900	900mm
RB 1200	1200mm

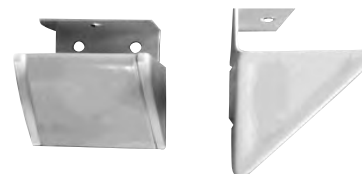

SHELVES

Standard Finishes

- White Melteca
- MDF

Other Finishes

- Coloured Melteca
- Lacquered MDF

Lengths

- 600mm
- 900mm
- 1200mm
- 1800mm
- 2400mm

Depths

- 150mm
- 200mm
- 250mm
- 300mm
- 400mm
- 600mm

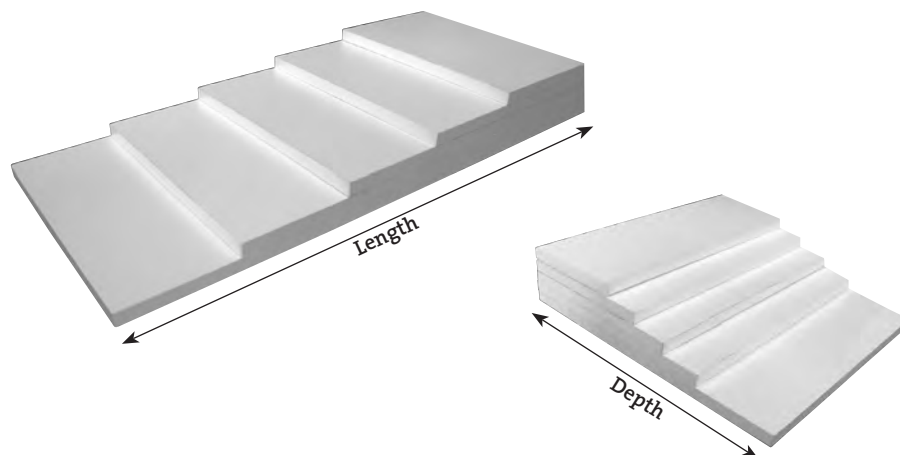

PEG PRONGS *Custom Built Prongs Available*

SINGLE HOOKS

1941	WH1	15mm
1942	WH2	20mm
1943	WH3	35mm
1944	WH4	20mm
1945	WH5	30mm
1946	WH6	45mm

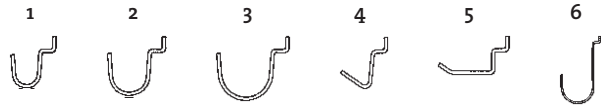

WIRE FITTINGS

Single Prong

1952	WFS2	50mm
1954	WFS4	100mm
1956	WFS6	150mm
1958	WFS8	200mm
1959	WFS10	250mm
1960	WFS12	300mm

Double Prong Open Front

1962	WFDO2	50mm
1964	WFDO4	100mm
1966	WFDO6	150mm
1968	WFDO8	200mm

Double Prong Closed Front

1972	WFDC2	50mm
1974	WFDC4	100mm
1976	WFDC6	150mm
1978	WFDC8	200mm

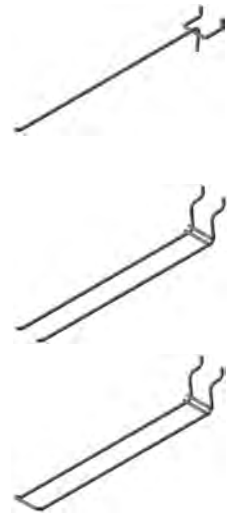

HEAVY DUTY FITTINGS

Double Prong Open Front

1992	HDD2	50mm
1994	HDD4	100mm
1996	HDD6	150mm
1998	HDD8	200mm

Single Prong

1982	HDS2	50mm
1984	HDS4	100mm
1986	HDS6	150mm
1988	HDS8	200mm
1989	HDS10	250mm
1990	HDS12	300mm

Single Prong with Pricing Strip

2010	100mm with Fixed Pricing Strip
2011	150mm with Fixed Pricing Strip
2012	200mm with Fixed Pricing Strip
2013	250mm with Fixed Pricing Strip
2020	100mm AKP with Flapper Pricing Strip
2021	150mm AKP with Flapper Pricing Strip
2022	200mm AKP with Flapper Pricing Strip
2023	250mm AKP with Flapper Pricing Strip
2024	300mm AKP with Flapper Pricing Strip

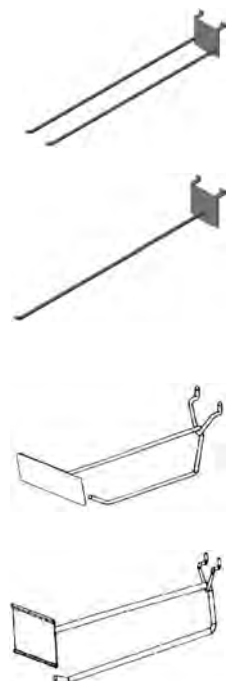

CROSSBARS AND FITTINGS

CROSSBARS Chrome Plated

1331	Module Bar – 725mm
1336	Module Bar – 900mm
1332	Module Bar – 1200mm
1333	Centre Fixer
1334	End Fixer – LH
1335	End Fixer – RH
2954	Straight Crossbar – 900mm – Lug Fix
2955	Straight Crossbar – 1200mm – Lug Fix
2952	U-Form Crossbar – 900mm – Lug Fix – 150mm Arm
2953	U-Form Crossbar – 1200mm – Lug Fix – 150mm Arm
2956	U-Form Crossbar – 900mm – Lug Fix – 300mm Arm
2957	U-Form Crossbar – 1200mm – Lug Fix – 300mm Arm

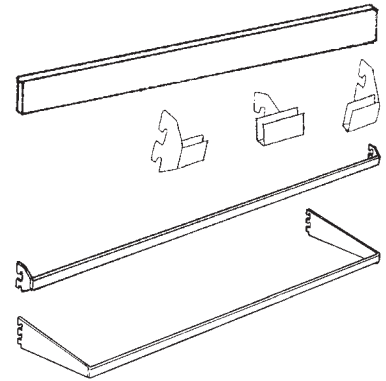

WATERFALLS Chrome Plated

1353	Crossbar – 8 Step
1355	Crossbar – 12 Step
1347	Crossbar – 6 Hook
1349	Lugfix – 8 Step
1357	Lugfix – 12 Step
1350	Screw-On – 8 Step
1359	Screw-On – 12 Step
1352	Mesh-Fix – 8 Step

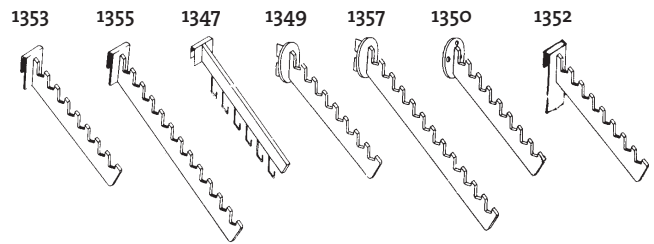

SALAMI PRONGS Chrome Plated

1371	Salami Prong – 200mm	Not Shown
1372	Salami Prong – 280mm	Not Shown
1373	Salami Prong – 310mm	Not Shown

CROSS BAR PRONGS

1338	50mm LD Single Prong
1339	100mm LD Single Prong
1341	150mm LD Single Prong
1340	200mm LD Single Prong
1342	250mm LD Single Prong
1930	100mm AKP Single Prong
1931	150mm AKP Single Prong
1932	200mm AKP Single Prong
1933	250mm AKP Single Prong
1934	300mm AKP Single Prong
1369	200mm Tubular Bracket (not shown)
1375	300mm Tubular Bracket (not shown)

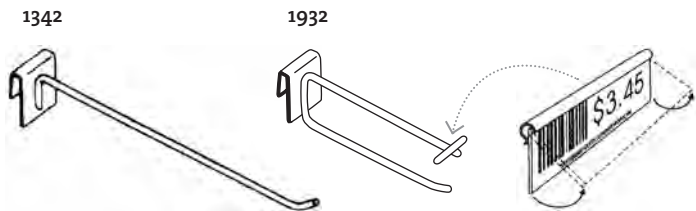

CLOTHING RACKS

4 ARM CLOTHING RACKS

3615 W Waterfall Arm
3615 S Straight Arm
3629 A Clip-On Straight Arm



SINGLE RAIL CLOTHING RACKS

3645 S Folding Salesman
1280mm - 1880mm long
3647 Folding Compact
825mm - 1225mm long



DOUBLE RAIL CLOTHING RACKS

3645 D Folding Double
1280mm - 1880mm long
3643 Fixed Double
1500mm long



OTHER CLOTHING RACKS

3635 Circular Rack - 950mm diameter
3637 Spiral Rack
3654 Sign Holder
- A4 with stem & magnetic base



SLATPANEL DISPLAY UNITS

LET US DESIGN & CUSTOM BUILD YOUR DISPLAY UNITS

1. Slatpanel Gondolas

Slatpanel Gondolas have proven consistently successful promoting most stock types effectively and economically

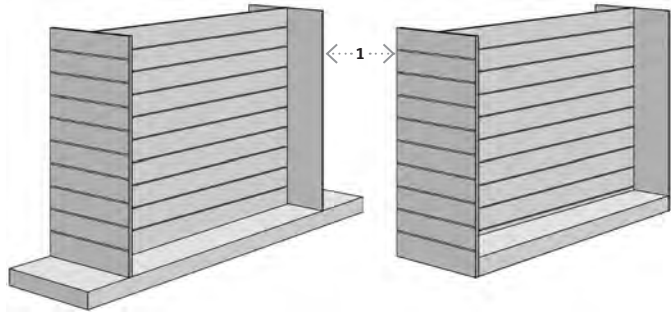

2. Slatpanel Infills

The Slatpanel Infills add versatility to standard shelving fixtures



3. Point of Sale

Custom designed Point of Sale stands feature flexibility for changing requirements

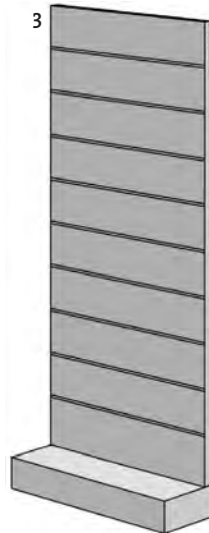

4. Four-Way Slatpanels

Slimline four-way Slatpanels can be made to revolve for convenient customer selection

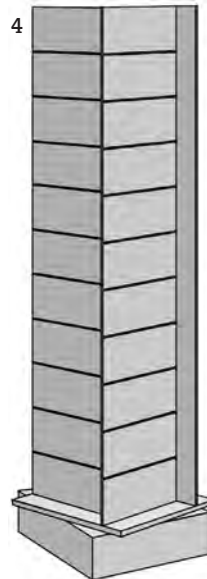

5. Four-Way Slatpanel Floor Units

Four-way Slatpanel Floor Units are ideal in heavy traffic areas.



Phone for further ideas

SLATPANELS

CHOOSE YOUR SPECIFICATIONS

1. Format

- Landscape – 2400mm wide x 1200mm high
- Portrait – 2400mm high x 1200 wide

2. Pitch (Slot Spacing)

- 75mm
- 100mm
- 150mm

3. Colours

- White
- MDF (Unpainted)
- Colour (Melamine Colours)

4. Inserts

- Plastic - White
 - Grey
 - Black
- Aluminium - Mill Finish
- No Inserts

5. Edge Capping

- Plastic - White
 - Grey
 - Black
- Aluminium

6. Corner Flashing

- Aluminium - Mill Finish
 - Internal Angle
 - External Angle

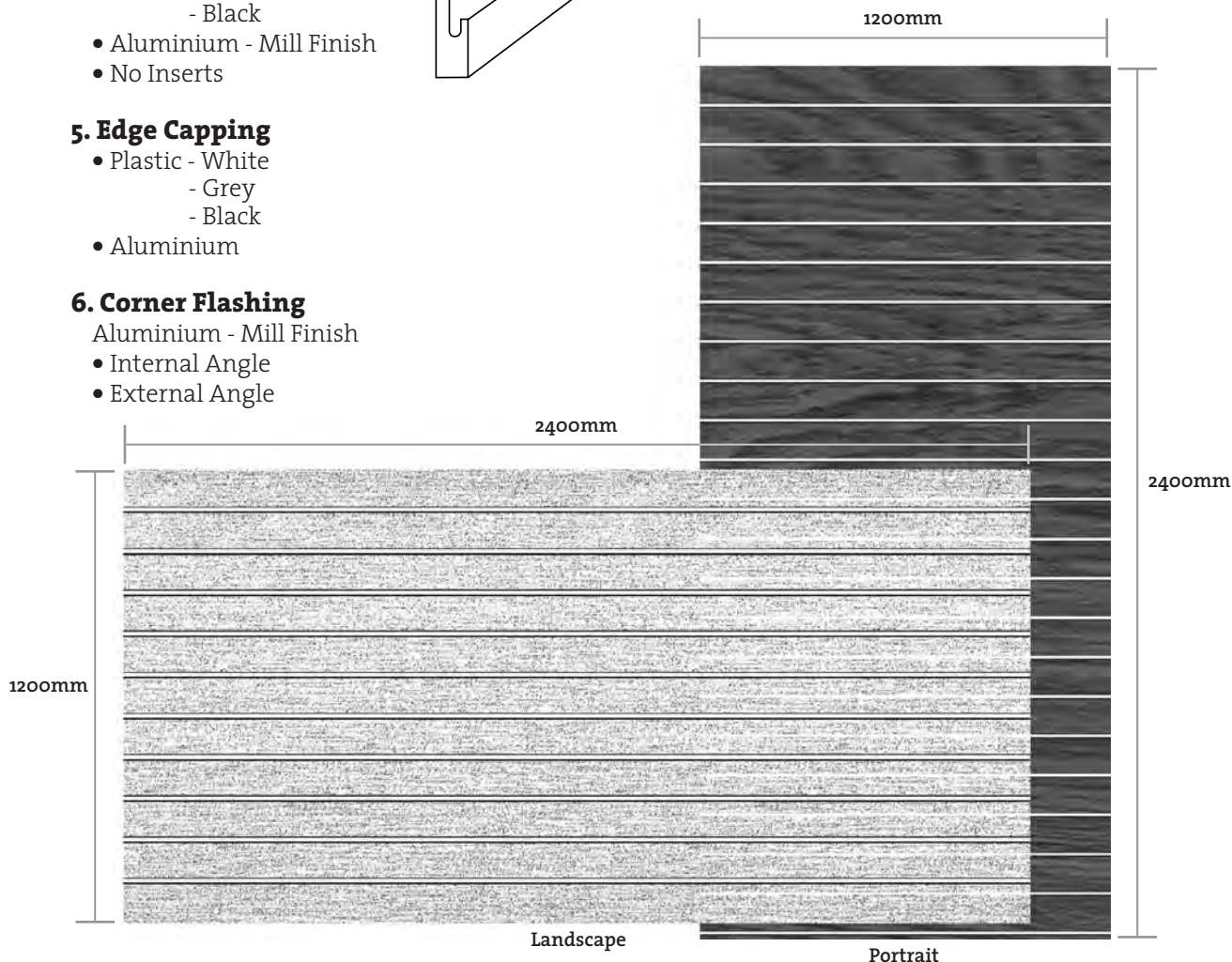
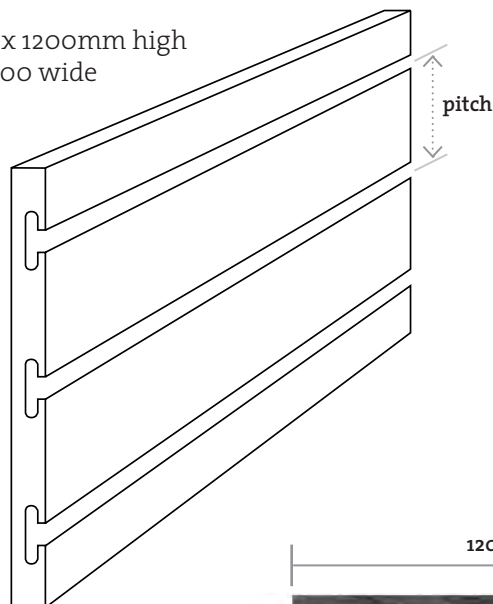

SLATPANEL FITTINGS

BRACKETS

Tubular Bracket

- 2215 300mm Straight
- 2215c4 400mm Straight

Flat Bracket

- 2222 150mm Straight
- 2223 200mm Straight
- 2224 250mm Straight
- 2225 300mm Straight
- 2226 350mm Straight

Adjustable Bracket – Zinc Plated

- 1111SP 200mm AT
- 1112SP 250mm AT
- 1113SP 300mm AT
- 1114SP 350mm AT
- 1115SP 400mm AT
- 1116SP 450mm AT

Tilt Support

- 1118

Slatwall Prong

- 2278 50mm
- 2276 100mm
- 2272 150mm
- 2274 200mm
- 2273 250mm
- 2277 300mm

2215

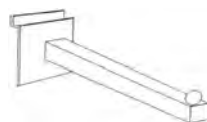

2225

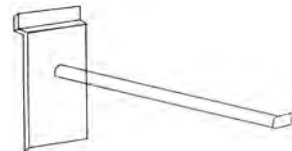
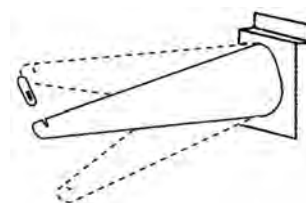
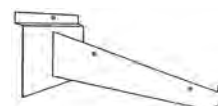

OTHER ACCESSORIES

Ball Holder

- 2275 150mm Diameter

Helmet Holder

- 2269

6-Hook Waterfall

- 2253

8-Step Waterfall

- 2254

12-Step Waterfall

- 2256

6-Ball Waterfall

- 2252

2275

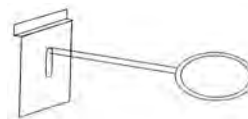

2269

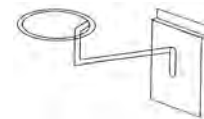

2253



2254



2256



2252

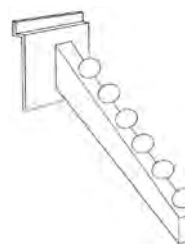

SLATPANEL FITTINGS

HANG RAILS & ACCESSORIES

Chrome-plated 25mm Diameter Tubing

1301	725mm
1302	892mm
1302N	892mm Notched
1303	1184mm
1304	1450mm
1305	1784mm
1308	2440mm
1309	3600mm

Custom sizes cut to order

1310	Tube Fixer
1311	Tube Joiner
1312	Tube Plug Plastic
1314	Wall Holder



1311



1310



1314



1312

PARTS BOXES

Bin with Divider

SB01	30L x 140W x 97H
SB02	130L x 290W x 97H
SB03	150L x 150W x 178H
SB04	275L x 280W x 170H

Bin

SB10	145L x 140W x 95H
SB20	235L x 140W x 95H
SB30	335L x 140W x 95H
SB21	136L x 140W x 98H
SB22	160L x 140W x 191H
SB23	357L x 280W x 183H
SB24	357L x 560W x 183H

SB01



SB04



SB20



SB22



SB23



SB24

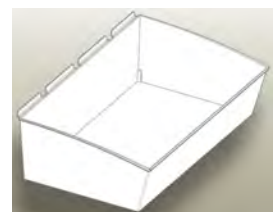

HANG RAILS & ACCESSORIES

2352	Cranked - Face Out
2355	Step Down - Face Out
2271	Hang Rack Set

2352

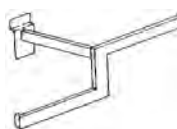

2355



2271



ACRYLIC SLATPANEL FITTINGS

ACRYLIC

Supported Shelf

400mm x 200mm (d)
600mm x 200mm (d)

Can custom build any size



Display Shelf

250mm x 100mm (d)
300mm x 150mm (d)
400mm x 280mm (d)

Can custom build any size



Sloping Shelf

2294 570mm x 320mm

Can custom build any size

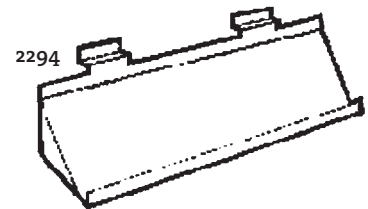

Video/Card Holder

2295 590mm (w) x 125mm (h) x 50mm (d) x 40mm

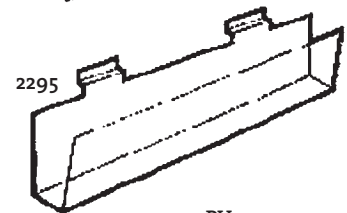

Brochure Holder

PV225 A4
PV156 A5
PV110 Tri-Fold
PSWB111 Slatpanel Bracket

See Pages 17-18 for further options

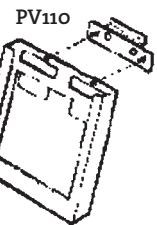

Slope Shoe Support

2236 Left Hand
2237 Right Hand



Forward Shoe Support

2234

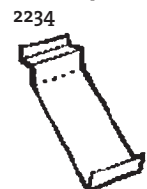

Flat Shoe Support

2230 250mm x 100mm (d)
250mm x 100mm (d) with sign holder



Frame Corners (PR)

2296

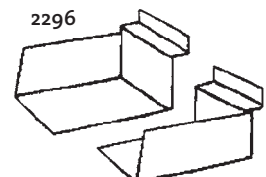

METAL SLATPANEL FITTINGS

SHELVES all finished in gloss white

S/P Metal Shelf

- 2310 150mm deep x 150mm wide
- 2312 150mm deep x 300mm wide
- 2314 200mm deep x 200mm wide
- 2316 200mm deep x 400mm wide
- 2317 200mm deep x 580mm wide
- 2320 300mm deep x 300mm wide
- 2321 300mm deep x 580mm wide

Custom sizes made to order

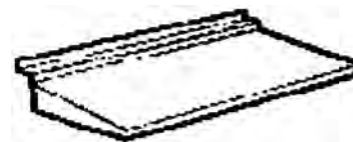

ACCESSORIES made to order

Flat Shoe Shelf

- 2325 100mm deep x 300mm wide

Face-Out Shoe Shelf, Toe Support

- 2326

S/P Swivel Shoe Shelf, Toe Support

- 2327

S/P Box

- 2330 Small – 150mm deep x 100mm wide x 100mm height
- 2331 Medium – 200mm deep x 150mm wide x 130mm height
- 2332 Large – 250mm deep x 200mm wide x 175mm height

S/P V-Shelf

- 2300 1300mm deep x 150mm pitch

S/P End V-Shelf

- 2300E 150mm pitch

S/P Metal Bin Shelf

- 2301 230mm deep x 490mm wide x 50mm height

Custom sizes made to order

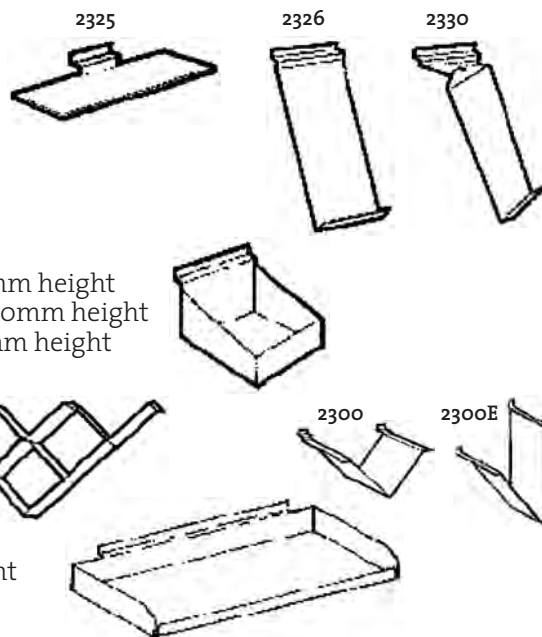

WIRE BASKETS Chrome

Sloping Wire Basket

- 5247 600mm wide x 300mm deep x 100mm high
- 5284 Divider for Sloping Wire Basket

Tray Baskets – Chrome Plated

- 5248 900mm x 300mm x 100mm
- 5249 900mm x 380mm x 100mm
- 5250 885mm x 300mm x 100mm
- 5251 885mm x 380mm x 100mm
- 5252 720mm x 300mm x 100mm
- 5253 720mm x 380mm x 100mm

Tray Dividers – Chrome Plated

- 5285 300mm Divider
- 5286 380mm Divider

Slatpanel Brackets (for baskets)

- 2258 300mm Adjustable Notched
- 2259 380mm Adjustable Notched

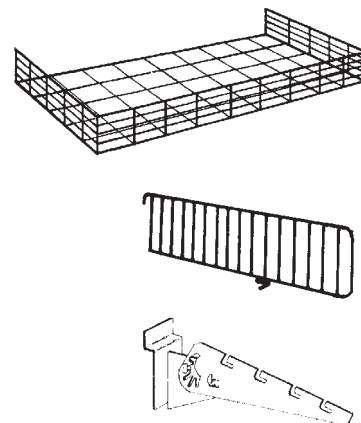

BROCHURE DISPLAYS

LET US DESIGN & CUSTOM BUILD YOUR DISPLAY UNITS

- Wall Displays
- Freestanding Displays
- Trolleys
- Sizes - A4, A5, Tri-Fold



BROCHURE HOLDERS

HOLDERS AND ACCESSORIES

PV225	A4 Brochure Holder
PV156	A5 Brochure Holder
PV110	Tri-Fold (DLE) Brochure Holder
PV180	Postcard Holder (not shown)
PBCH92	Business Card Holder, Clip-On
PVS80	Universal Base Bracket
PVB111	Universal Wall Bracket
PSWB111	Wire Slatpanel Brochure Clip
PVS221	Flop Stopper
PWB450	Wall Bracket 450mm
PWB895	Wall Bracket 895mm
PWB2400	Wall Bracket 2400mm
PWB3600	Wall Bracket 3600mm

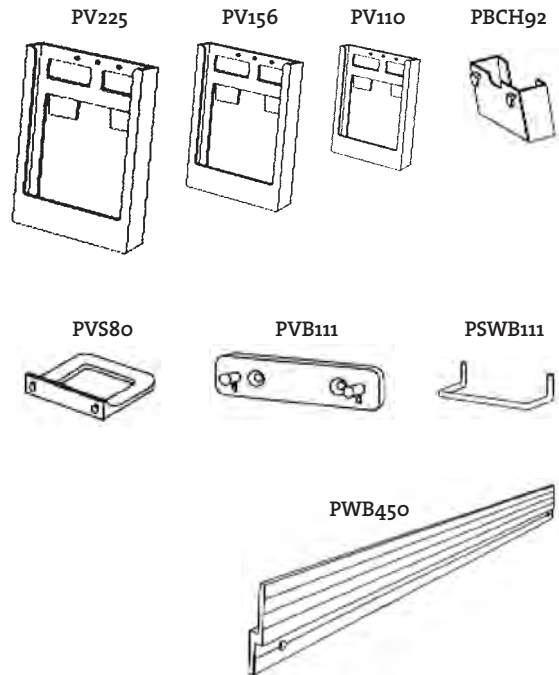

Custom sizes cut to order

TROLLEYS AND STANDS

PH1	High Floor Stand – One Sided
PB1	Half Trolley – Two Sided
PB2	Full Trolley – Two Sided

Make up your own combination of holders

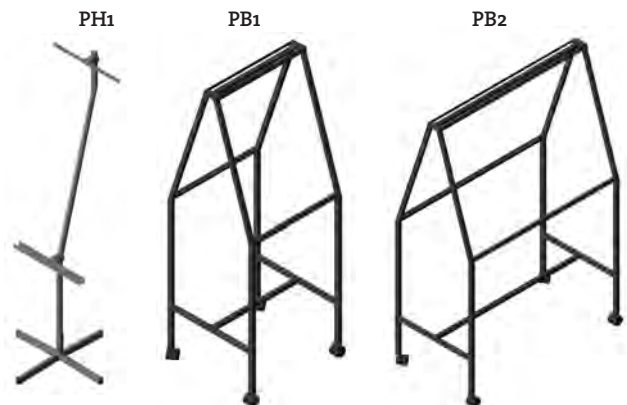

BROCHURE STANDS

STANDS AND ACCESSORIES

16TF 16 x Trifold Wall Display
450mm wide x 550mm high

F8A416TF Combination Wall Display
8 x A4 and 16 x Tri-Fold
900mm wide x 680mm high

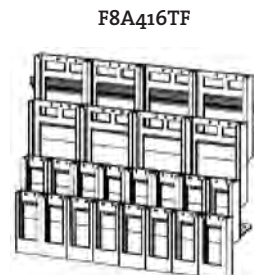
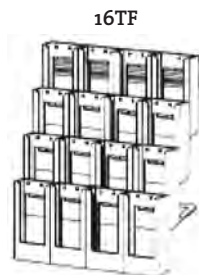

TR80TF Trolley for 80 Trifold Holders
960mm wide x 1260mm high

TR40TF Trolley for 40 Trifold Holders
480mm wide x 1260mm high

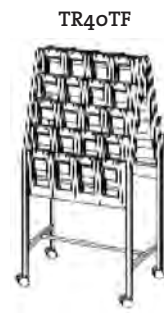
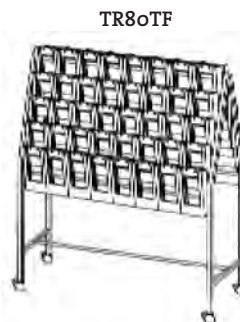

TR32A4 Trolley for 32 A4 Holders
960mm wide x 1260mm high

TR16A4 Trolley for 16 A4 Holders
480mm wide x 1260mm high

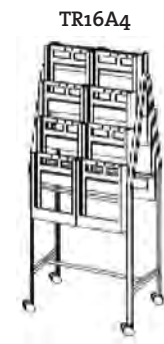

F12A4 Foyer Stand for 12 x A4 Holders
520mm wide x 1650mm high

F16TFA4 Combination Foyer Stand
6 x A4 and 16 x Tri-Fold
520mm wide x 1650mm high

F6A4 Foyer Stand for 6 x A4 Holders
520mm wide x 1650mm high



MAGAZINE HOLDERS

FREESTANDING

- 6410 A4 x 6 - 280mm x 1460mm x 370mm
Silver alloy and acrylic with slanted shelves.
Two-sided display. Collapsible (concertina)
with bag (450mm x 300mm x 150mm)
- 6415 A4 x 7 - 300mm x 1590mm x 390mm
Black powder coated frame with slanted
shelves and castors. Two-sided display.
- 6420 A4 x 8 - 440mm x 1380mm x 410mm
Black powder coated frame with plastic
coated wire shelves and castors.
Single-sided display. Can also hold a
mixture of A3, A4, A5 and DLE brochures.



MAGAZINE HOLDER 3mm Clear Acrylic

A4 size
A4 Oversize (for magazines)

		WIDTH	HEIGHT	DEPTH
6430	4 Pocket	225mm	715mm	100mm
6431	4 Pocket	245mm	715mm	100mm
6432	5 Pocket	225mm	915mm	100mm
6433	5 Pocket	245mm	915mm	100mm
6434	6 Pocket	225mm	1075mm	100mm
6435	6 Pocket	245mm	1075mm	100mm
6440	910mm mounting rail for display shelving			



REAL ESTATE STANDS

- RESstd A4 - Standard Wire Stand, landscape or portrait
Custom sizes made to order
- 6450 Outside A4 Holder
260mm (w) x 330mm (h) x 110mm (d)
Clear with black lid
DLE and A5 also available



ACRYLIC DISPLAYS

- 6504 A4 Vertical Menu Holder
- 6513 A5 Vertical Menu Holder
- 6533 Tri-Fold Vertical Menu Holder
- 6523 A6 Vertical Menu Holder

- 6501 A4 Wall Copy Holder
- 6511 A5 Wall Copy Holder
- 6521 A6 Wall Copy Holder

- 6503 A4 Sloping Menu Holder
- 6510 A5 Sloping Menu Holder
- 6514 Tri-Fold Sloping Menu Holder
- 6520 A6 Sloping Menu Holder

- 6537 Shelf Talker

- 6535 Mini Counter Display Stand
- 6536 Open Book Display Stand

- 6530 Business Card Holder

- Plate1 Plate Holder Small
- Plate2 Plate Holder Medium
- Plate3 Plate Holder Large

- Shoe1 Shoe Display 80mm
- Shoe2 Shoe Display 120mm
- Shoe3 Shoe Display 160mm

- 6529 Business Card Holder - 4 Pocket

- 6540 A4 Freestanding Brochure Holder
- 6541 A5 Freestanding Brochure Holder
- 6542 Tri-Fold Freestanding Brochure Holder

- 6550 A4 4 Pocket Brochure Holder
- 6551 A5 4 Pocket Brochure Holder
- 6552 Tri-Fold 4 Pocket Brochure Holder

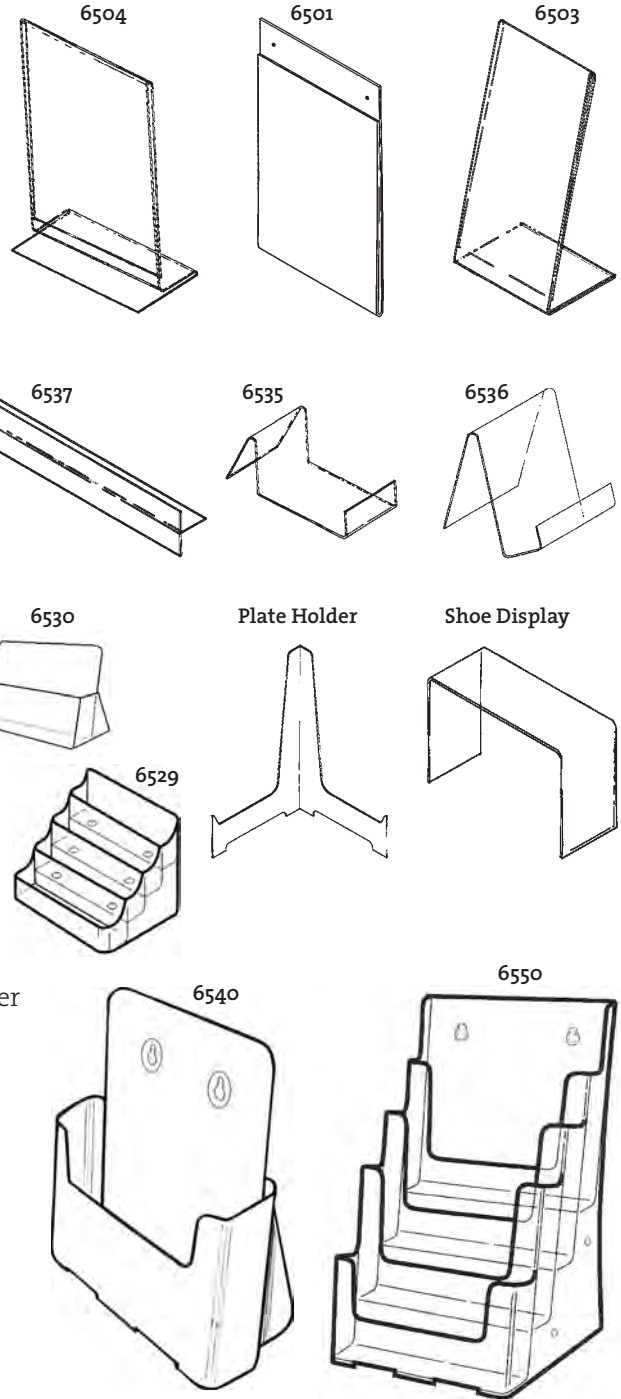

GLASS DISPLAY CABINETS

LET US DESIGN & CUSTOM BUILD YOUR DISPLAY UNITS

All glass display cabinets are lockable.
All glass display cabinets are custom built to order.
Also available with lighting.

Towers

- GTS 1855 1800h x 500 x 500 with storage base
- GTP 1855 1800h x 500 x 500 on plyth base

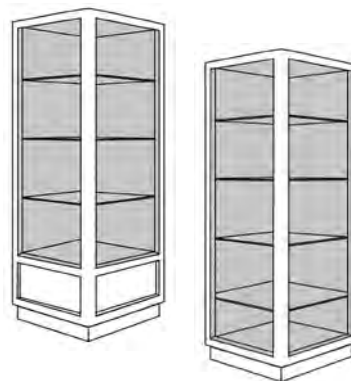

Counters

- GCL 1295 1200h x 900 x 500 on legs
- GCP 1295 1200h x 900 x 500 on plyth base

Also available with storage base

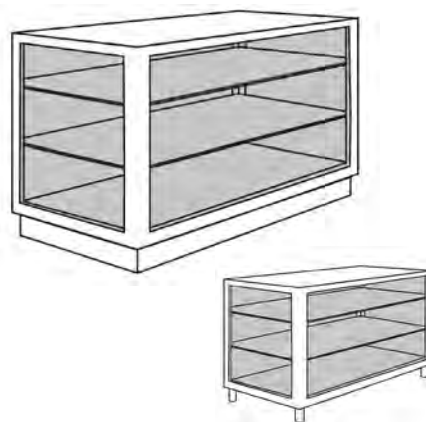

Display Cases

- GDS 18105 1800h x 1000 x 500 with storage base
- GDP 18105 1800h x 1000 x 500 on plyth base

Also available with legs

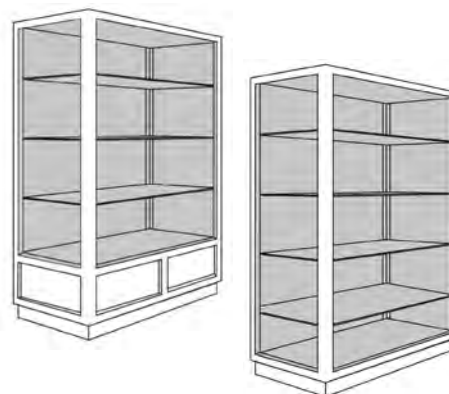

Other sizes and styles also available – please enquire

GLASS CABINETS

MODULOC complete with locking doors, castors and adjustable shelves

- 3544 1220h x 500mm x 500mm with 3 shelves
- 3545 1520h x 500mm x 500mm with 4 shelves
- 3546 1820h x 500mm x 500mm with 5 shelves
- 3547 1520h x 1000mm x 500mm with 3 shelves
- 3549 620h x 400mm x 400mm with 2 shelves

Options

- Storage base with lock
- Plinth base (no castors)
- Light box (Halogen)
- Extra glass shelves
- Toughened glass



Standard with Castors



Plinth Base

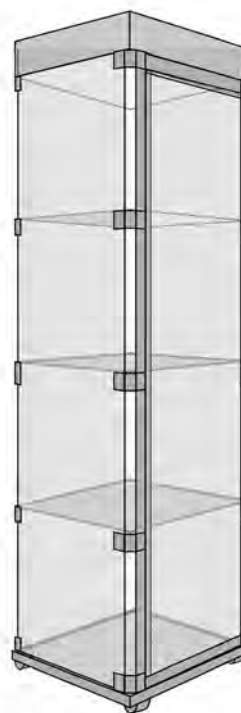

Halogen Light Box

DISPLAY SHELVING

FREE STANDING DISPLAY POSTS Double Slotted

Single Sided L-Post

1715LG	1190mm high x 250mm leg
1715G	1190mm high x 300mm leg
1717LG	1470mm high x 250mm leg
1717G	1470mm high x 300mm leg
1721G	1700mm high x 300mm leg
1723G	1980mm high x 300mm leg
1725G	2285mm high x 300mm leg

Double Sided T-Post

1716LG	1190mm high x 250mm leg
1716G	1190mm high x 300mm leg
1718LG	1470mm high x 250mm leg
1718G	1470mm high x 300mm leg
1722G	1700mm high x 300mm leg
1724G	1980mm high x 300mm leg
1726G	2285mm high x 300mm leg

Tie-Rods Display System – will carry infill panels

1711DG	560mm (600mm module)
1712DG	695mm (725mm module)
1713DG	860mm (900mm module)
1710	Tie-Rod Wall Fixing Plate

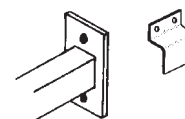
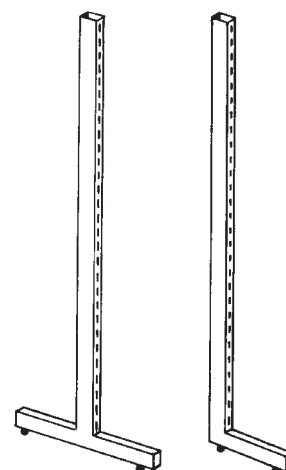

STEEL SHELVES & BRACKETS

Plain Shelves - also see pages 9 & 10

1810	900mm x 200mm
1811	900mm x 250mm
1812	900mm x 300mm
1813	900mm x 375mm
1814	900mm x 450mm
1701G	885mm x 200mm
1702G	885mm x 250mm
1703G	885mm x 300mm
1704G	885mm x 375mm
1705G	885mm x 450mm
1262G	720mm x 200mm
1263G	720mm x 250mm
1264G	720mm x 300mm
1265G	720mm x 375mm
1266G	720mm x 450mm

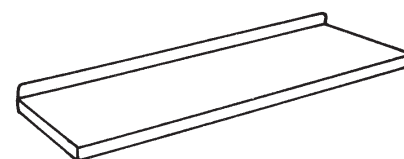

Tabbed Brackets – Zinc Plated (for steel shelves)

1161	200mm Fixed SS Tab
1162	250mm Fixed SS Tab
1163	300mm Fixed SS Tab
1164	375mm Fixed SS Tab
1165	450mm Fixed SS Tab
1122	200mm Adjustable SS Tab
1124	300mm Adjustable SS Tab

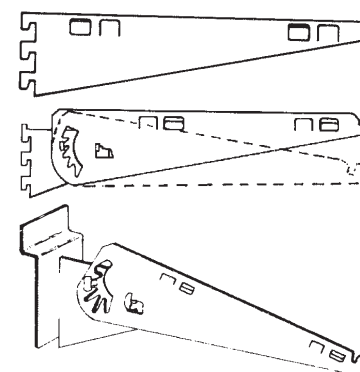

Slatpanel Brackets (for steel shelves)

2283	200mm Adjustable SS Tab
2285	300mm Adjustable SS Tab

SHELVING ACCESSORIES

ACCESSORIES

Clear Ticket Strip – Self Adhesive

- 8007 DBR Flat – 26mm x 915mm
- 8001 No 45° Angle – 26mm x 915mm

Other styles & sizes available - please enquire

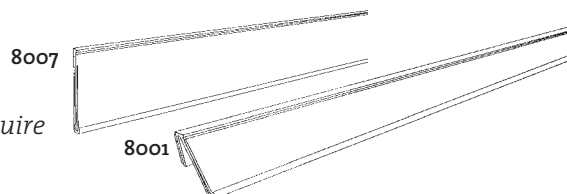

Two Lug Fixers – Zinc Plated

- 1141 Flat Support
- 1142 Flat Screw-On
- 1145 Bent LH Screw-On
- 1146 Bent RH Screw-On
- 1147 Bent LH Support
- 1148 Bent RH Support

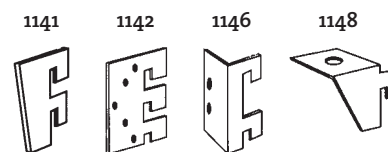

Pelmet Brackets – Finished White

Adjustable: 500mm – 900mm

- 1131 Top Fix
- 1132 Bottom Fix
- 1133 Screw-On

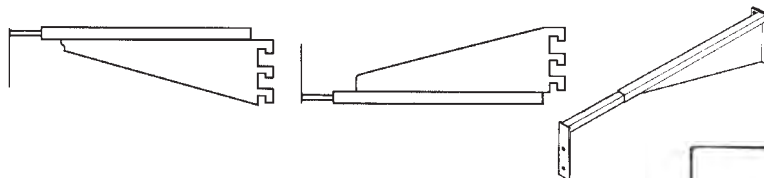

Card Frames

- 3649 A5 Landscape
- 3650 A5 Portrait
- 3653 A4 Landscape
- 3654 A4 Portrait
- 3657 A3 Landscape
- 3659 A3 Portrait
- 3658 Card Frame Base
Stem & T Piece

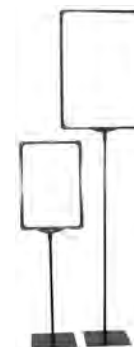

Twin Wheel Castors

- 1437 3/8 BSW thread
- 1435 Round – Black 3/8 BSW Adjustable Foot

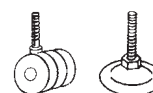

WIRE BASKETS

Tray Baskets – Chrome Plated

- 5248 900mm x 300mm x 100mm
- 5249 900mm x 380mm x 100mm
- 5250 885mm x 300mm x 100mm
- 5251 885mm x 380mm x 100mm
- 5252 720mm x 300mm x 100mm
- 5253 720mm x 380mm x 100mm

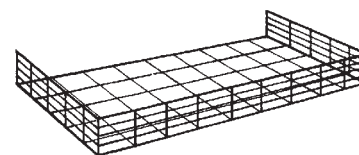

Tray Dividers – Chrome Plated

- 5285 300mm Divider
- 5286 380mm Divider



Notched Brackets – Zinc Plated (for tray baskets)

- 1088N 300mm Fixed Notched
- 1089N 380mm Fixed Notched
- 1108N 300mm Adjustable Notched
- 1109N 380mm Adjustable Notched

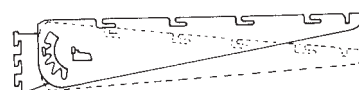

Slatpanel Brackets (for baskets)

- 2258 300mm Adjustable Notched
- 2259 380mm Adjustable Notched

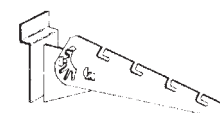

LIBRARY SHELVING

FREE STANDING LIBRARY POSTS Double Slotted

Double Sided T-Post

1715LG	1190mm high x 250mm leg
1715G	1190mm high x 300mm leg
1717LG	1470mm high x 250mm leg
1717G	1470mm high x 300mm leg
1721G	1700mm high x 300mm leg
1723G	1980mm high x 300mm leg
1725G	2285mm high x 300mm leg

Double Sided T-Post

1716LG	1190mm high x 250mm leg
1716G	1190mm high x 300mm leg
1718LG	1470mm high x 250mm leg
1718G	1470mm high x 300mm leg
1722G	1700mm high x 300mm leg
1724G	1980mm high x 300mm leg
1726G	2285mm high x 300mm leg

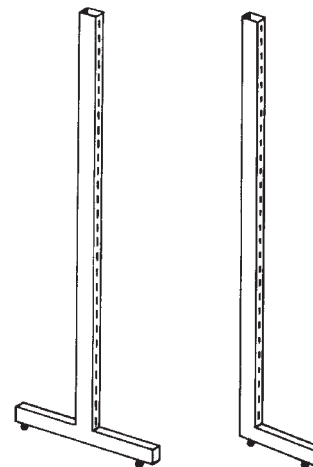

TIE-RODS LIBRARY SYSTEM

1712LG	703mm (725mm module)
1713LG	868mm (900mm module)
1712LG	Tie-Rod Fixing Plate



LIBRARY SHELVES AND BRACKETS

Canopy Shelves - also see pages 7 & 10

1803	900mm x 300mm
1802	900mm x 250mm
1706	897mm x 300mm
1736	897mm x 250mm

High Back Shelves

1812	900mm x 250mm x 90mm high
1708	885mm x 250mm x 90mm high

Blades for Steel Shelving - Tabbed, Black, Sold as Pairs

1200	200mm x 150mm high
1201	250mm x 150mm high
1202	300mm x 150mm high
1205	250mm x 100mm high uptilt

Blades for Timber Shelving - Black, Sold as Pairs

1742	200mm x 150mm high
1743	250mm x 150mm high
1744	300mm x 150mm high
1745	250mm x 100mm sloping

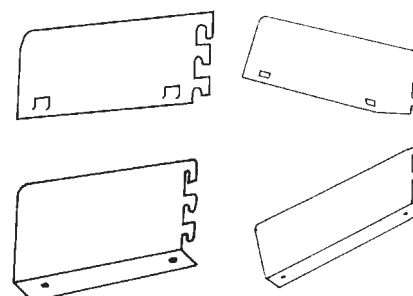
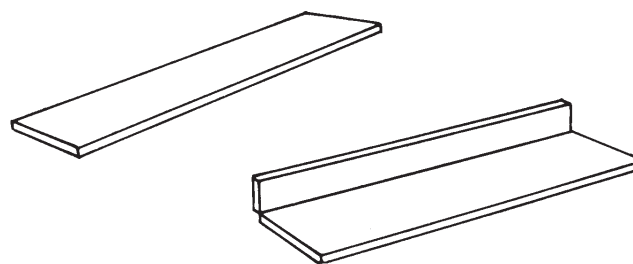

BOOKENDS

1748	120mm x 180mm high - Grey or Off White
------	--

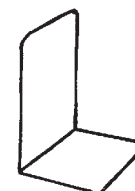

LIBRARY SHELVING - CONT

LIBRARY ACCESSORIES

1. Kickplate
2. Periodical Display Shelf
3. Clearview Display Shelf
4. Base Uptilt Shelf
5. Serial Shelf
6. Divider Shelf Set
7. Browser Bin
8. Cassette Shelf
9. CD Shelf
10. 2-Tier Magazine Unit
- 10A. 3-Tier Magazine Unit
11. Audio Visual Bag Rail
12. Pamphlet Shelf Set
13. Canopy Shelf
14. 15° - 60° Display Shelf
15. 45° Display Shelf
16. Sliding Reference Shelf Set
17. Uptilted Display Bin
18. Rear Display Panel
19. AV Shelf (2,3 & 4 Tier also available)
20. Paperback System
21. Zig Zag Support
22. Perf End Panel
23. 60° End Shelf

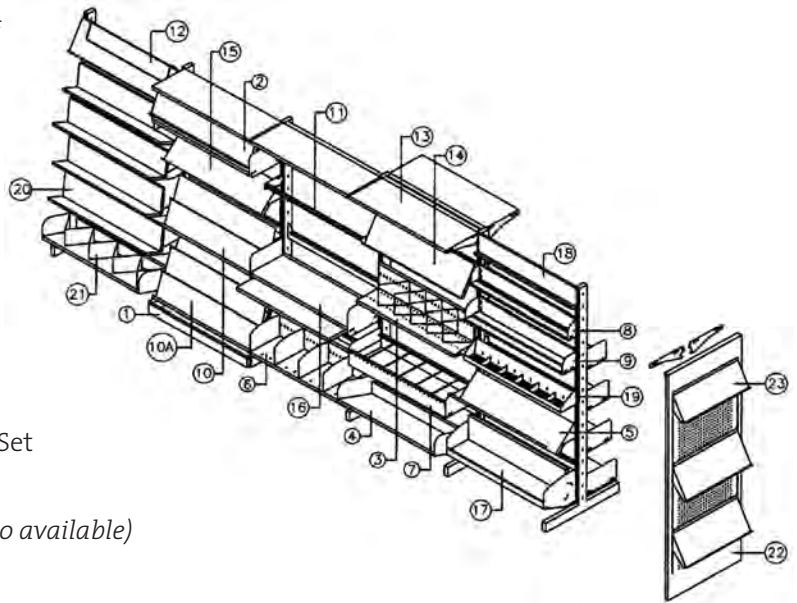

Sundry Items: Bookends - Royale & Standard
Indicator Blocks (A-Z's)

GENERAL BOOK SHELVES

General Book Shelf

- | | |
|------|----------------------------|
| 1822 | 900mm x 150mm x 200mm high |
| 1707 | 885mm x 150mm x 200mm high |
| 1269 | 720mm x 150mm x 200mm high |

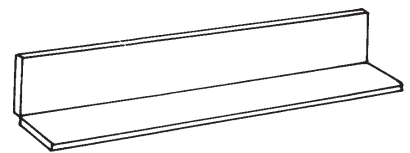

General Book Shelf Brackets - Zinc Plated

- | | |
|------|----------------------------|
| 1086 | 200mm GBS - 2 Lug |
| 1096 | 210mm GBS Extended - 3 Lug |
| 1097 | 280mm GBS Extended - 3 Lug |
| 1098 | 330mm GBS Extended - 3 Lug |
| 1099 | 440mm GBS Extended - 3 Lug |

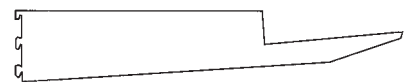
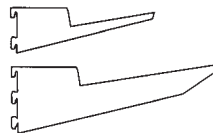

Paperback Book Shelf

- | | |
|-------|----------------------------|
| 1832 | 900mm x 110mm x 200mm high |
| 1700G | 885mm x 110mm x 200mm high |
| 1268G | 720mm x 110mm x 200mm high |

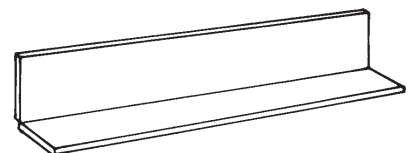

Paperback Book Shelf Brackets - Zinc Plated

- | | |
|-------|--------------------|
| 1096P | 175mm PBS |
| 1097P | 245mm PBS Extended |
| 1098P | 355mm PBS Extended |
| 1099P | 440mm PBS Extended |



CHROME SHELVING

SHELVING UNITS Complete with four shelves

- EW360 1800mm high x 360mm deep x 910mm wide
- EW460 1800mm high x 460mm deep x 460mm wide
- EW600 1800mm high x 460mm deep x 610mm wide
- EW900 1800mm high x 460mm deep x 910mm wide
- EW1200 1800mm high x 460mm deep x 1220mm wide
- EW1500 1800mm high x 460mm deep x 1530mm wide

Other heights available on request

Posts

1800mm high posts

Shelves

- 910mm x 360mm
- 460mm x 460mm
- 610mm x 460mm
- 910mm x 460mm
- 1220mm x 460mm
- 1530mm x 460mm

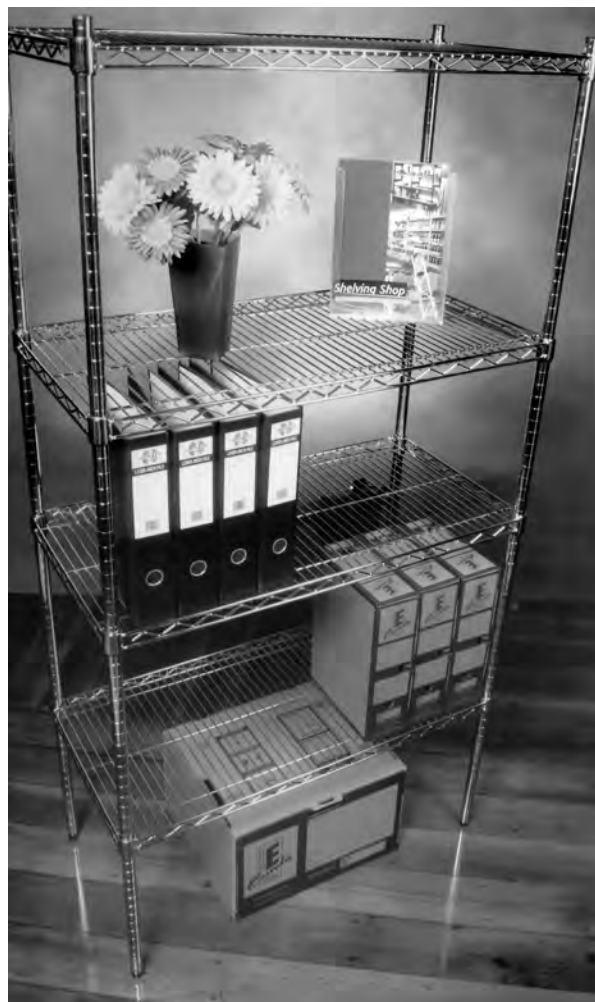

COMPONENTS

- 460mm shelf edges
- 610mm shelf edges
- 910mm shelf edges
- 1220mm shelf edges
- Castors – 75mm, set of four (two with brakes)
- 'S' hooks
- Post clamps
- Data strips
- Sign holders
- Brochure holders
- Plastic inlay shelves
- 460mm handle
- Shelf Clips (Set of 8)

Other components available on request

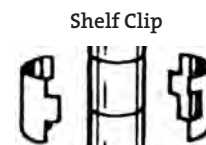
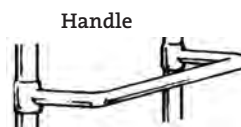
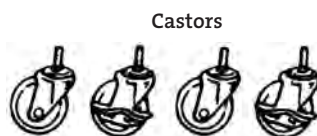

CLOTHES HANGERS

Ask about our complete range of clothes hangers



SIZE DIVIDERS

Available in a great range of colours, numbers and letters

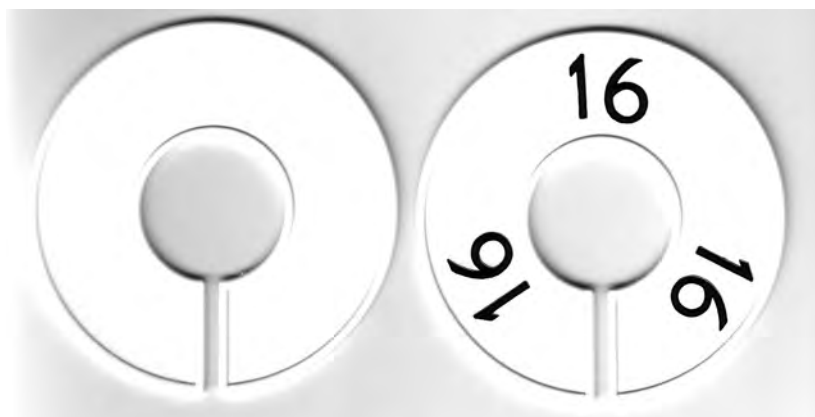

MANNEQUINS

BODY FORMS

- BFM-1 Male
- BFFM-1 Female
- BFC-1 Child



FULL MANNEQUINS

- Male
- Female
- Base

Others available - please enquire

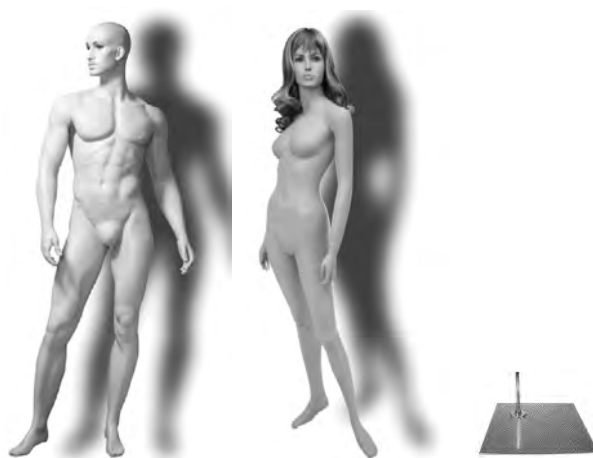

TORSOS

- SK1 Female - no arms
- SH3 Female - with arms
- SH4 Male - with arms
- HD6 Male - no arms
- BAS-03 Base

Others available - please enquire

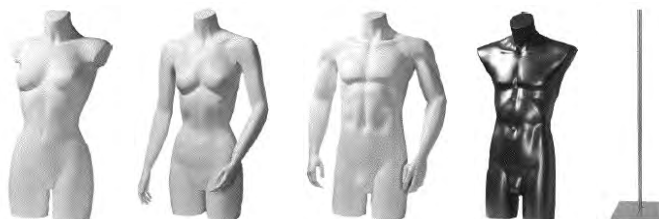

SECURITY MIRRORS

INTERIOR CONVEX MIRRORS

'De-Lux' Convex Mirror. Supplied complete with back and 'J' mounting bracket.

Wall - Full (360°)

4015	diam - 300mm	Acrylic face	ICD - up to 5m*
4016	diam - 450mm	Acrylic face	ICD - up to 7m*
4017	diam - 600mm	Acrylic face	ICD - up to 10m*
4018	diam - 760mm	Acrylic face	ICD - up to 13m*
4019	diam - 900mm	Acrylic face	ICD - up to 18m*
4020	diam - 1200mm	Acrylic face	ICD - over 5m*
4030	diam - 600mm	Glass face	ICD - up to 10m*

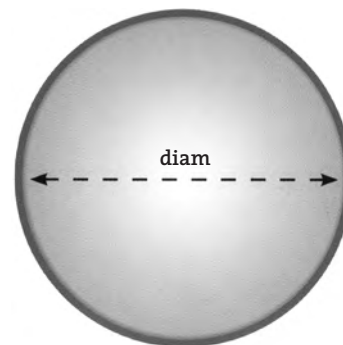

INTERIOR HEMISPHERE MIRRORS

Wall - Quarter (90°)

4080	300mm x 300mm	ICD - up to 3m*
4081	450mm x 450mm	ICD - up to 6m*
4082	600mm x 600mm	ICD - up to 10m*



Wall - Half (180°)

4073	600mm x 300mm	ICD - up to 6m*
4074	900mm x 450mm	ICD - up to 9m*
4075	1200mm x 600mm	ICD - up to 14m*



Ceiling - Full (360°) Dome

4083	600mm	ICD - up to 6m*
4084	900mm	ICD - up to 6m*
4085	1200mm	ICD - up to 16m*



*ICD (Interior Combined Distance) - Combined distance from site you intend to install mirror - add distance from the viewer to the distance to the area to be observed.

Exterior mirrors also available.